

# CL5800N

## 19" Dual Rail PS/2-USB LCD Console

The CL5800N is a series of KVM Console modules featuring an integrated 19" LCD panel, a full keyboard, and a touch pad in a 1U rack-mountable sliding housing





The CL5800N's LCD and keyboard/touch pad modules slide independently of each other. To maximize space in your data center, the keyboard/touch pad module slides back to "hide away" when not in use, while the thin profile LCD monitor rotates back – flush against the rack – allowing convenient monitoring of computer activity.

For added convenience, ports for an external PS/2 or USB keyboard and mouse as well as a monitor are provided on the rear panel.

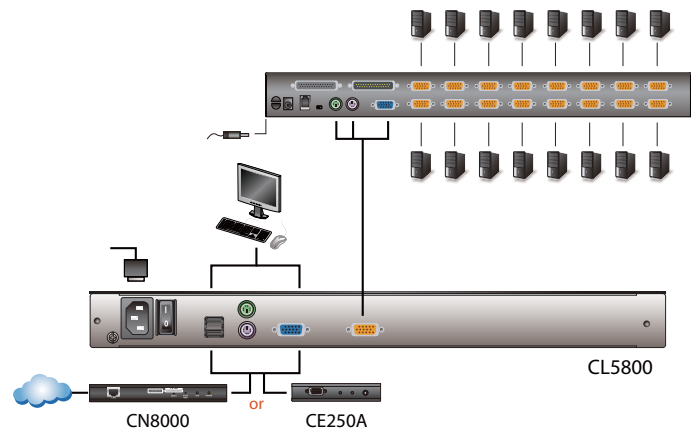

### Setup

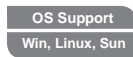

 2nd Consoles PS/2, USB	 Computers SPHD PS/2, USB	 Shared Access 2 Local Users
 OS Support Win, Linux, Sun	 LCD Monitor 19"	 External Mouse USB

Bracket Type	Size (cm)
Standard Installation – Long	70.0—105.0
Easy Installation – Short	57.0—70.0
Easy Installation – Long	68.0—105.0

### Features

- Integrated KVM console with a 19" LCD monitor in a dual rail housing with top and bottom clearance for smooth operation in a 1U high system rack
- Standard rack mount kit included – optional Easy Rack Mounting (single person installation) rack mount kit available (requires separate purchase)
- Supports an external console\* with either PS/2 or USB connectors
- Dual interface – Supports computers and KVM switches with PS/2 or USB keyboards and mice
- Additional hot-pluggable USB mouse port on front panel (also functions as USB peripheral port)
- Internal power supply
- High video resolution:
  - Up to 1280 x 1024 @75Hz
  - Supports DDC, DDC2, DDC2B
  - DDC emulation of the LCD monitor
  - Video settings of attached computers are automatically adjusted for optimal output to the LCD monitor
- Standard 105-key keyboard; Sun keyboard emulation
- Dual rail design allows LCD monitor and keyboard/touch pad modules to operate independently
- Compatible with all ATEN KVM Switches and most other KVM switches
- Adjustable depth to fit within the rack
- Firmware upgradeable
- Supports Microsoft Intellimouse (5 keys)
- Supports Logitech and Microsoft wireless mice
- Console lock – enables the console drawer to remain securely locked away in position when not in use

\* Attach a KVM extender to remotely access the computers down the hall or halfway around the world (CN8000) via the Internet.

### Specifications

Function		CL5800N	
Computer Connections		1	
Console Selection		Hotkey	
Connectors	External Console Ports	Keyboard	1 x 6-pin Mini-DIN Female (Purple) 1 x USB Type A Female (Black)
		Video	1 x HDB-15 Female (Blue)
	Mouse	1 x 6-pin Mini-DIN Female (Green) 1 x USB Type A Female (Black)	
		KVM Ports	1 x SPHD-18 Female (Yellow)
	USB Port	1 x USB Type A Female (Black)	
	FW Upgrade	1 x RJ-11	
	Power	1 x 3-prong AC Socket	
Switches	Reset	1 x Semi-recessed Pushbutton	
	Power	1 x Rocker	
	F/W Upgrade	1 x Slide	
	LCD Power	1 x Pushbutton	
LEDs	Lock	LCD Adjustment	4 x Pushbutton
		Power	1 (Dark Green)
		LCD Power	1 (Orange)
		Num	1 (Green)
Emulation	Keyboard / Mouse	Caps	1 (Green)
		Scroll	1 (Green)
		PS/2; USB	
Video		1280 x 1024@75Hz, DDC2B	
I/P Rating		100–240VAC; 50–60Hz; 1A	
Power Consumption		32.2W	
Environment	Operating Temp.	0–50°C	
	Storage Temp.	-20–60°C	
	Humidity	0–80% RH Non-condensing	
Physical Properties	Housing	Metal	
	Weight	14.76 kg	
	Dimensions (L x W x H)	68.04 x 48.00 x 4.40 cm	

\* The specifications and pictures are subject to change without notice.

## ATEN North America