

DH-IPC-EB5531

5MP Panaromic Network Fisheye Camera



- 1/2.5" 5Megapixel progressive scan CMOS
- H.265&H.264 triple-stream encoding
- 25fps@5MP(2592×1944) ,25/30fps@3MP(2048×1520)
- Smart Detection supported
- WDR(120dB), 3DNR,AWB,AGC,BLC
- Multiple network monitoring: Web viewer, CMS(DSS/PSS) & DMSS
- 1.4mm fixed lens
- Built-in Mic
- Micro SD memory, IP67, PoE



System Overview

Eco-savvy products by upgrading H.265 encoding technology, bringing high efficient video compression. It saves bandwidth and storage, energy-saving design to enhance the monitoring system. It provides excellent image quality and intelligent and efficient event reminders. This series provides IP67 waterproof protection feature. Give customers more value.

Functions

Intelligent Video System (IVS)

With built-in intelligent video analytics, the camera has the ability to detect and analyze moving objects for improved video surveillance. The camera provides optional standard intelligence at the edge allowing detection of multiple object behaviors such as abandoned or missing objects. IVS also supports Tripwire analytics, allowing the camera to detect when a pre-determined line has been crossed, ideal for business intelligence.

Environmental

With a temperature range of -30 °C to +60 °C (-22 °F to +140 °F), the camera is designed for extreme temperature environments. The IP67 rating makes it suitable for demanding outdoor applications. For environments with rain, sleet, snow and fog, an integrated wiper provides users with clear visibility at all times.

Protection

Supporting ±30% input voltage tolerance, this camera suits even the most unstable conditions for outdoor applications. Its 4KV lightning rating provides protection against the camera and its structure from the effects of lightning.

Smart H.265+

Deliver high quality video without straining the network, Smart H.265+ is the optimized implementation of H.265. The Smart H.265+ encoding

technology includes a scene adaptive encoding strategy, dynamic GOP, dynamic ROI, flexible multi-frame reference structure and intelligent noise reduction, providing saving of up to 70% of bandwidth and storage when compared with standard H.265.

HEVC (H.265)

H.265 ITU-T VCEG is a new video coding standard. H.265 Following standard developed around the existing video coding standard H.264, some retain the original technology, while some of the relevant technology to improve the new technology uses advanced technology to improve the relationship between the code stream, encoding quality, and the delay between algorithm complexity, optimize settings specific contents include: Improve compression efficiency, improve the robustness and error recovery capabilities, real-time to reduce the delay, reduce channel acquisition time and a random access delay, reduce complexity, etc

Technical Specification**Camera**

Image Sensor	1/2.5" 5Megapixel progressive scan CMOS
Effective Pixels	2592(H)x1944(V)
RAM/ROM	512MB/32MB
Scanning System	Progressive
Electronic Shutter Speed	Auto/Manual, 1/3(4)~1/100000s
Minimum Illumination	0.02Lux/F1.6(Color,1/3s,30IRE) 0.2Lux/1.6(Color,1/30s,30IRE) 0.05Lux/F1.6(B/W,1/3s,30IRE) 0.5Lux/1.6(B/W,1/30s,30IRE)
S/N Ratio	More than 50dB
IR Distance	N/A
IR On/Off Control	N/A
IR LEDs	N/A

Lens

Lens Type	Fixed				
Mount Type	Board-in				
Focal Length	1.4mm				
Max. Aperture	F1.6				
Angle of View	H: 180°, V: 180°				
Optical Zoom	N/A				
Focus Control	Fixed				
Close Focus Distance	N/A				
DORI Distance	Lens	Detect	Observe	Recognize	Identify
	1.4mm	28m(92ft)	11m(36ft)	6m(20ft)	3m(10ft)

Pan/Tilt/Rotation

Pan/Tilt/Rotation Range	Pan:0°~355°; Tilt:0°~75°; Rotation:0°~360°
-------------------------	--

Intelligence

Advanced Intelligent Functions	Tripwire, Intrusion, Heat map
--------------------------------	-------------------------------

Video

Compression	H.265+/H.265/H.264+/H.264
Streaming Capability	3 Streams
Resolution	5M(2592x1944)/3M(2048x1536)/ UXGA(1600x1200)/1.3M(1280x960)/ D1(704x576/704x480)/CIF(352x288/352x240)
Frame Rate	Main Stream:5M(1~25fps)
	Sub Stream: D1(1~25/30fps)
Bit Rate Control	CBR/VBR
Bit Rate	H.264: 24~10240Kbps H.265: 14~9984Kbps
Day/Night	Electronic

BLC Mode	BLC / HLC / WDR
White Balance	Auto/Natural/Street Lamp/Outdoor/Manual
Gain Control	Auto/Manual
Noise Reduction	3D DNR
Motion Detetion	Off / On (4 Zone, Rectangle)
Region of Interest	Off / On (4 Zone)
Electronic Image Stabilization (EIS)	N/A
Smart IR	N/A
Defog	N/A
Digital Zoom	16x
Flip	N/A
Mirror	Off / On
Privacy Masking	Off / On (4 Area, Rectangle)

Audio

Compression	G.711a/ G.711Mu/ AAC/ G.726
-------------	-----------------------------

Network

Ethernet	RJ-45 (10/100Base-T)
Protocol	HTTP; HTTPS; TCP; ARP; RTSP; RTP; UDP; SMTP; FTP; DHCP; DNS; DDNS; PPPOE; IPv4/v6; QoS; UPnP;NTP; Bonjour; 802.1x; Multicast; ICMP; IGMP; SNMP
Interoperability	ONVIF, PSIA, CGI
Streaming Method	Unicast / Multicast
Max. User Access	10 Users /20 Users
Edge Storage	NAS Local PC for instant recording Mirco SD card 128GB
Web Viewer	IE, Chrome, Firefox, Safari
Management Software	Smart PSS, DSS, Easy4ip
Smart Phone	IOS, Android

Certifications

Certifications	CE (EN 60950:2000) UL:UL60950-1 FCC: FCC Part 15 Subpart B
----------------	--

Interface

Video Interface	N/A
Audio Interface	Built-in Mic
RS485	N/A
Alarm	N/A

Electrical

Power Supply	DC12V, PoE (802.3af)(Class 0)
Power Consumption	<3.4W

Environmental

Operating Conditions	-30° C ~ +60° C (-22° F ~ +140° F) / Less than 95% RH
Storage Conditions	-30° C ~ +60° C (-22° F ~ +140° F) / Less than 95% RH
Ingress Protection	IP67
Vandal Resistance	IK08

Construction

Casing	Metal
Dimensions	Φ110mm×56mm (4.33"×2.2")
Net Weight	0.38Kg (0.84lb)
Gross Weight	0.44Kg (0.97lb)

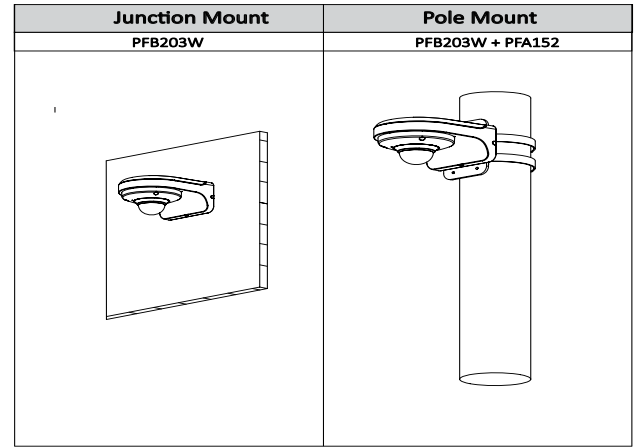

Ordering Information

Type	Part Number	Description
5MP camera	DH-IPC-EB5531P	5MP Panaromic Network Fisheye Camera, PAL
	DH-IPC-EB5531N	5MP Panaromic Network Fisheye Camera, NTSC
	IPC-EB5531P	5MP Panaromic Network Fisheye Camera, PAL
	IPC-EB5531P	5MP Panaromic Network Fisheye Camera, NTSC
Accessories (optional)	PFA152-E	Pole Mount
	PFB203W	Wall Mount

Dimensions (mm/inch)

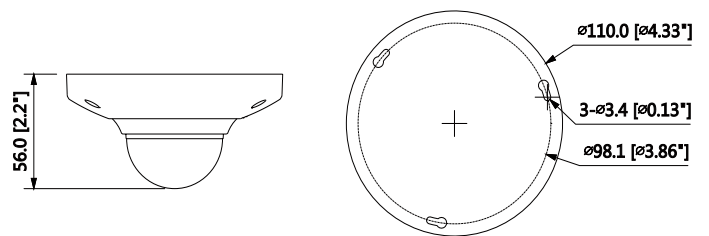

Accessories

Optional:

